



# SEALANT RESTORATION GUIDE





Tremco is proud to provide you with this updated version of the Sealant Restoration Guide. The purpose of this guide is to identify key considerations and provide assistance regarding proper joint sealant restoration for those installing sealant materials in construction projects.

With over 80 years of experience in the waterproofing industry, Tremco has been a leader in providing weatherproofing solutions in construction projects around the world. The guidelines included in this booklet are a collection of that experience combined with Tremco's pursuit of product excellence through research and innovation.

Executing the guidelines found in Tremco's updated Sealant Restoration Guide will help to ensure the success and maximum product life of your joint sealant restoration projects along with improved efficiency and productivity on sealant restoration jobs using any of our broadened line of high performance sealants.

Other companion documents that should be used as references are Tremco's product data sheets and application instructions as well as an expanded arsenal of tools to help select the appropriate product for an application and tools for use under challenging conditions or to track jobsite conditions:

- Tremco Sealant Selection Guide (located inside the back pocket of this guide)
- Tremco Sealants-Certifications & Validations (located inside the back pocket of this guide)
- Tremco Website for Cold Weather Caulking Instructions
- Tremco Website for Sealant and Primer Usage Calculators
- Jobsite Log (located inside the back pocket of this guide)

This guide is broken down into steps to consider throughout a typical joint sealant restoration project.

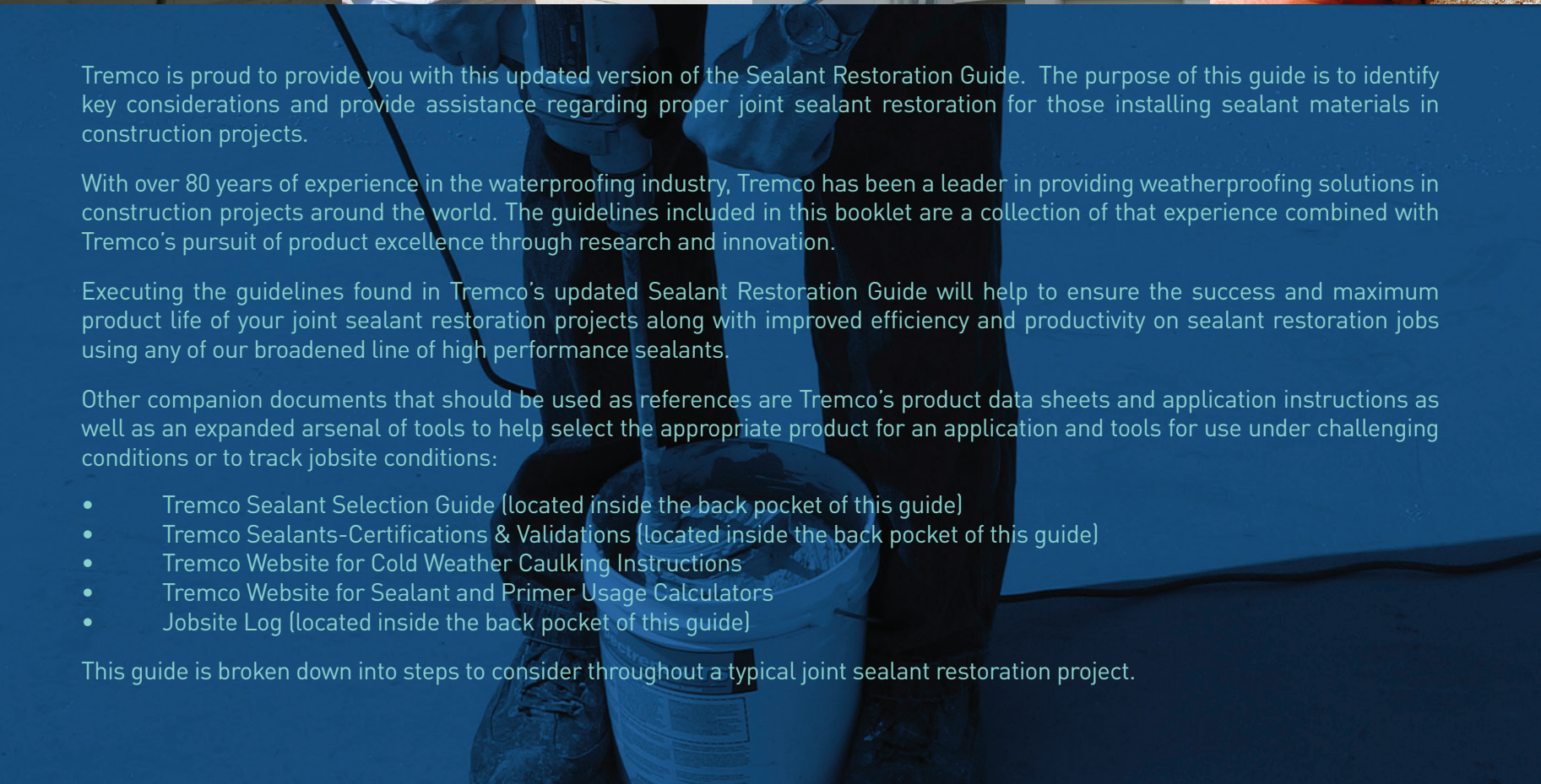

# CONTENTS

SECTION	PAGE NUMBER
1. Documenting performance	2
2. Your local Tremco Sales Representative	5
3. Identifying the reasons for joint sealant restoration	6
4. Choosing from the joint sealant restoration options	11
5. Selecting the appropriate products	13
6. Determining the joint preparation approach	16
7. Product installation guidelines	21
8. Appendix	26
a. Types of substrates	26
b. Calculating joint movement	31
c. Sealant joint design	33
d. Sealant joint profiles	34
9. Sealant usage chart	35

## SECTION 1 – DOCUMENTING PERFORMANCE

Tremco strives to maintain consistency in the manufacturing of its products, which is why we are ISO 9001/9002 certified. This commitment to consistency can be easily extended to the jobsite.

Regardless of the motivation for the restoration work, the existing condition of the building joint seals and the overall wall system should be documented. Documentation of the existing building conditions allows for a reference point and gives a better basis for potential troubleshooting. By documenting the project, you also develop a project background you can use for future restoration projects.

A visual inspection or survey of the building joints should be conducted. This may require the use of specialty construction materials, such as a swing stage, man lift, boatswain chairs, or other similar types of equipment. The extent of the survey needs to be decided upon before starting the project. It may be decided that a partial survey, such as one drop per elevation, will provide enough information to proceed.

### JOBSITE LOG

It is recommended that the sealant applicator maintain a Jobsite Log or record. An example of a Jobsite Log can be found in the pocket of this document. The log chronicles the daily progression of the project and is invaluable should troubleshooting be necessary. The daily log should include the following information:

- Date and description of the weather conditions, including average air temperature
- Location(s) of the joints that were sealed that day
- Record of the crew(s) and where they worked that day
- Batch numbers of the sealant and primer (if required) used in each location
- Notes of any unusual conditions encountered that day
- A record of checking the previous work completed for quality and performance

A field adhesion test log should be maintained as well. The following paragraph, VERIFYING SEALANT ADHESION, will explain this process further. The field adhesion log should record:

- Date and location of the adhesion test
- Installed age of sealant
- Test results
- Type of failure that occurs upon full extension of the sealant, cohesive or adhesive
- Percent extension of sealant prior to cohesive or adhesive failure
- Sealant configuration (width and depth)

Section 1 describes the jobsite log and recommended field adhesion testing procedures. Documenting the procedures in this section helps to ensure installation consistency and performance throughout the project.

# 1 DOCUMENTING PERFORMANCE

## VERIFYING SEALANT ADHESION

The field adhesion test is a valuable tool for verifying the installed quality of the joint seal. Performing this test prior to the application allows for early detection of problems, which can help to minimize the cost associated with sealant restoration projects. Potential problems that could be detected using this field adhesion test include:

- Contaminated or expired shelf life sealant or primer
- Improper substrate cleaning
- Incorrect primer selection
- Improper joint configuration
- Poor priming techniques
- Three-sided adhesion (i.e. absence of or improper installation of backing material)
- Excessive substrate movement
- Presence of bond breaking material(s) at bond lines (i.e. moisture, frost, incompatible coatings, etc.)

The field adhesion test is simply a hand pull test of a cut area of joint sealant (Figure 1.1). The testing procedure can be found in Appendix X.I of ASTM C1193, Standard Guide for Use of Joint Sealants. It is a very useful tool for evaluating the effects of various cleaning methods and primers. It is also a good indicator of the fundamental adhesive properties of a sealant on a particular substrate. It is most important to verify adhesion and joint configuration at the start of the project for the various construction materials that may come in contact with the sealant(s) used. We recommend that one adhesion test be performed every 100' (31 m) of joint over the first 1,000' (305 m) of install sealant as soon as the sealant has fully cured.

If good results are obtained from the tests of the first 1,000' (305 m), future field adhesion testing should proceed at a lesser rate of:

- 1) One test per 1,000' (305 m)
- 2) One test per floor per elevation
- 3) One test per week per installation crew

If poor results are obtained in a field adhesion test, work should be stopped to verify the root cause and magnitude of the problem. Once the cause of the problem is identified, corrective measures can be implemented. The area yielding the poor results should be identified by additional, more frequent field adhesion tests in the affected area(s). The daily log should be analyzed to see if there is anything unique about the poor results area. Good results are defined as meeting the standards for adhesion and joint configuration established in the mock-up application. Conversely, poor results are not meeting these established standards.



FIGURE 1.1 – ADHESION PULL TEST

## REPAIR OF THE FIELD ADHESION TEST AREA

The field adhesion test is a destructive test that should be repaired immediately. This will help to maintain the weatherproofing integrity of the repaired area. In most cases, it is simply a matter of gunning in new sealant to replace the cut area. Ensure that the original sealant surfaces are clean and that the new sealant fully wets out all contact areas. Refer to the sealant data sheet or contact your local Tremco Field Representative for correct tie-in procedures.

## SECTION 2 – YOUR LOCAL TREMCO FIELD REPRESENTATIVE

Tremco is committed to providing you with support personnel to help with every step of your joint sealant restoration project. The Tremco Technical Service Group and the Tremco Research and Development Center support your fully qualified Tremco Sales Representative. Together, their knowledge and experience provides you with the expertise to ensure that your joint sealant restoration project delivers the desired results. Your local Tremco Sales Representative is available to assist you with:

- Initial jobsite inspections
- Identification of the joint sealant restoration options
- Planning, execution, and evaluation of the site mock-up application
- Preparation of project specifications
- Pre-installation meetings
- On-site contractor instruction
- Document periodic observation of the work in progress with a field report
- Ongoing post application observation(s) of the completed work
- Consultation of problem areas and the resolution options available

Your Tremco Support Personnel provide total coordination from the drawing board through job completion. To contact your local Tremco Sales Representative, call Tremco Customer Service at 800.321.7906 (U.S.A.) or 800.363.3213 (Canada). Sales Representative names, phone numbers, and email addresses are also available on our website at [www.tremcosealants.com](http://www.tremcosealants.com).

Section 2 explains the valuable tools and services available when you utilize your local Tremco Field Representative.

## 2 YOUR LOCAL TREMCO FIELD REPRESENTATIVE

## SECTION 3 – IDENTIFYING THE REASONS FOR JOINT SEALANT RESTORATION

Sealants should not be used to simply hide an underlying waterproofing or related moisture problem. A thorough evaluation of the existing conditions prior to starting the job will help to ensure the proper sealant is used and the sealant's anticipated service life is reached or exceeded. In addition to a thorough evaluation of the existing conditions, one should have a clear understanding of the reasons for sealant restoration. Joint sealants are typically restored for one or more of the following reasons:

- An existing seal has been breached and allows water and/or air leakage
- As preventative maintenance to avoid the costs and inconvenience of future seal failures
- For sealant that is or appears close to the end of its service life
- As part of a general building maintenance package

As mentioned in SECTION 1 – DOCUMENTING PERFORMANCE, the existing condition of the building joint seals and overall wall system should be documented. A visual inspection or survey of the building joints should be undertaken. This may require the use of a swing stage, man lift, boatswain chair, or other similar types of equipment. The extent of the survey needs to be decided upon before starting the project. It may be decided that a partial survey, such as one drop per elevation, will provide enough information to proceed. The survey should document the following information:

1) The joint substrate types. Appendix 8A gives a description of common building materials where sealants may be applied. The substrate type is required input for joint movement calculations. It is also a consideration when selecting replacement sealant products.

2) The joint locations, spacing, approximate linear footage, and joint configuration (width and depth). Also record the expected temperature range for that region. Typical and non-typical details should be sketched. Note location of non-typical areas.

3) The general condition of the substrate(s) and existing joint sealant. This includes noting the location and the approximate linear footage.

4) The general state of the building's exterior and specific areas of structural or waterproofing concern. When making general observations, take particular note of:

- Evidence of water leakage or efflorescence
- Wall cracking patterns and locations (See Figure 3.1)
- Wall panel relative positions - sound and in-line?
- Evidence of previous maintenance or repairs
- Existing deficiencies in the wall system

Section 3 describes the procedure for evaluating your restoration options. It includes a description of substrate types, recommended joint configuration, joint movement, and some of the issues that contribute to joint seal failure.

## 3 IDENTIFYING THE REASONS FOR JOINT SEALANT RESTORATION

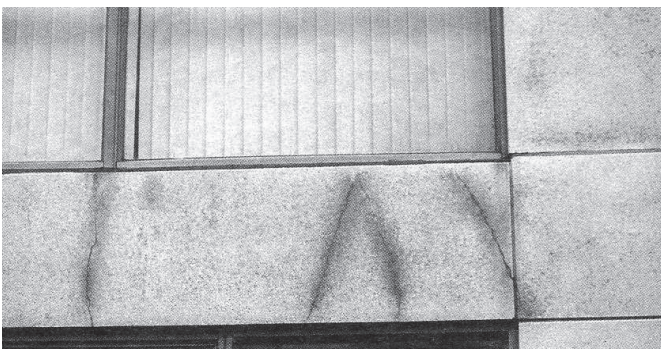

FIGURE 3.1 – WALL CRACKING PATTERNS



The joint configuration and sealant width and depth should be determined by cutting out samples in representative areas and measuring the sealant profile. There are four basic types of joint configurations listed below (refer to Figures 3.2 to 3.5):

- 1) Butt Joint (Figure 3.2)
- 2) Fillet or Angle Joint (Figure 3.3)
- 3) Lap Joint (Figure 3.4)
- 4) Bridge Joint (Figure 3.5)

Refer to Appendix 8D for more details on Sealant Joints.

In the cut out areas, the condition of the joint backing should be noted, including type and size. Check joint backing for moisture retention. Does it appear dry or wet? Is there staining on the backer rod? Include any observations made regarding any abnormal conditions of the wall interior and/or traces of water. Note if the substrates are in need of repair.

Joint sealants are required to accommodate normal building movement while still maintaining a seal. This movement combined with weathering effects can cause a gradual reduction in the sealant performance properties. The samples that are cut from the existing joint should be examined to determine joint configuration. Comment on the sealant appearance (both on the surface and within the bead), brittleness, and elastomeric properties. It is ideal to determine the age of the sealant if possible from the construction or maintenance records. You will also want to document the type of joint seal failures. A description of three main types of joint seal failures and their possible root causes is as follows:

A) Sealant Adhesive Bond Loss (Figure 3.6a & b) – Sealant adhesive bond loss is when the sealant has separated cleanly from the surface of the substrate. A gap may appear between the sealant and substrate.

Possible Root Cause – Sealant adhesive bond loss can be caused by improper substrate preparation, substrate contamination, or improper sealant installation. Sealant performance is very dependent on substrate preparation. Asking the following questions may help to pinpoint the root cause of a sealant failure:

- Upon inspection, is there evidence that dirt, oil, form release agents, or other contaminants are within the areas of bond loss?
- If a primer was used, was it applied properly?
- Is there evidence of excessive amounts of primer, insufficient or no primer, use of the wrong primer or primer contamination?
- Was the sealant installed properly?
- Is the bead width to depth ratio correct?
- Does it have the desired hourglass shape?
- Is three-sided adhesion occurring?

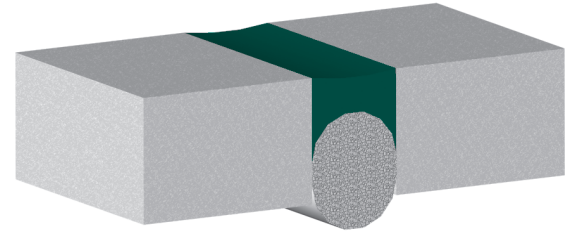

FIGURE 3.2 – BUTT JOINT

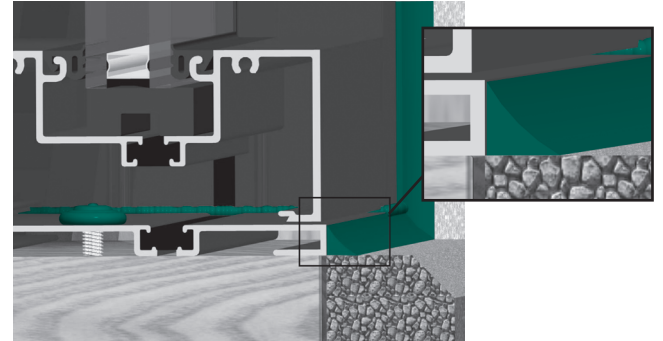

FIGURE 3.3 – FILLET OR ANGLE JOINT

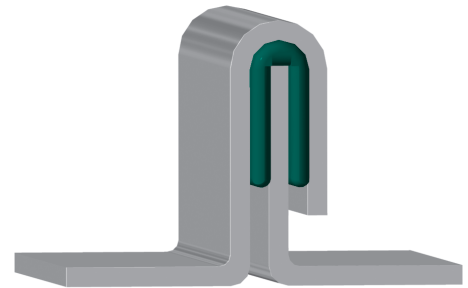

FIGURE 3.4 – LAP JOINT

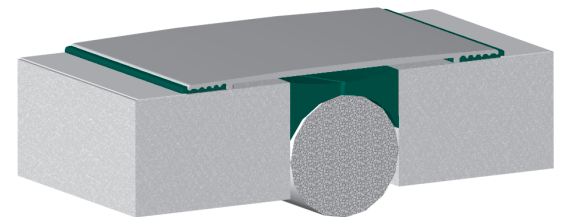

FIGURE 3.5 – BRIDGE JOINT

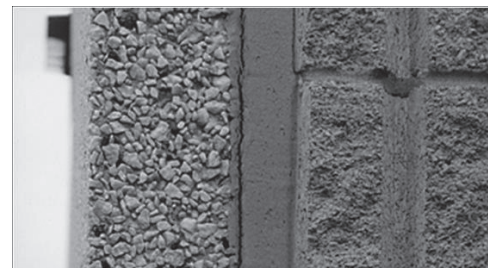

FIGURE 3.6a – SEALANT ADHESIVE BOND LOSS



FIGURE 3.6b – SEALANT ADHESIVE BOND LOSS

Sealant-substrate incompatibility may show itself as sealant adhesive bond loss. Sealants do not necessarily bond to all materials equally well. For example, a sealant that bonds well to glass may not bond well to granite. If all sealant bond loss is occurring on one substrate, an inherently weak bond may be causing the problem.



FIGURE 3.7 – SEALANT COHESIVE TEARING

B) Sealant Cohesive Tearing (Figure 3.7) – Sealant cohesive tearing is when a split or tear occurs within the body of the sealant bead. The split may go all the way through or just a portion of the bead. Generally the split is parallel to the length of the joint. This type of failure is due to excessive or restrictive movement.

Possible Root Cause – Sealant cohesive tearing usually results from joint movement being greater than the movement capability of the sealant or from improperly installed sealant. Excessive movement can be the result of poor joint design, improper sealant selection, or as-built joint widths that did not meet the design specifications.

To determine whether or not the joint movement exceeds the capability of the sealant, the following should be considered:

i) The existing sealant's joint design ratio. Sealant movement capability (a +/- percentage) alone is not the joint design ratio; other factors such as construction tolerances and installation inconsistencies should be included in this figuring process. This information may not be readily available. The product's joint design ratio is normally stated on the manufacturers' product literature. The typical industry standard for joint design is 4 times the anticipated joint movement. For example, if the anticipated movement in a joint is 1/4" (6 mm) of expansion/contraction, the recommended joint width would be 1" (25 mm). This is because a high-performance sealant would be able to accommodate at least 25% movement, or in the case of a 1" (25 mm) joint, the sealant could accept the 1/4" (6 mm) of expansion/contraction.

ii) The actual joint movement. It is possible to measure actual joint movement with the use of scratch gauges or other methods (See Figure 3.10). This approach can produce valid movement dimensions provided the gauges are allowed to record movement over an annual cycle. Another approach is to calculate the theoretical joint thermal movement using the method described in Appendix 8B.

If the actual joint movement exceeds the joint design ratio, cohesive tearing may occur. Another common cause of cohesive tearing is improper sealant application. Bead profiles that are too thin have a tendency to easily tear or split. Bead profiles that are too thick increase bond line stress, decreasing movement capability, resulting in tears and splits.

C) Substrate failure (Figure 3.8) is when the substrate ruptures or degrades at or near the sealant bond line. The sealant remains adhered to the substrate, but the substrate separates from itself.

Possible Root Cause - One possible cause of substrate failure is the adhesive and cohesive strength of the sealant being greater than the cohesive strength of the substrate. Joint failures of this type usually appear at first glance to be sealant adhesive bond loss. Close examination of the bond line shows that the substrate is embedded in the sealant surface. Prolonged water exposure and/or freeze thaw can often be the cause of this condition.

Joint seal failures are not necessarily apparent by visual inspection alone. A common technique for evaluating joint seal problems is to probe the joint seal during the inspection. Probing is simply applying a localized force at the center of the joint sealant, using a blunt instrument (Figure 3.9). This will simulate extension of the joint. It is important that care should be taken not to over-extend the joint by use of excessive force. Probing should be done during the inspection on a defined, repetitive basis. A typical approach is to probe every 3-5' of seal if no failures are observed. Failure areas should be probed on a continual basis until no failure is observed.

#### INDIRECT FAILURE ROOT CAUSES

Not all joint seal failures are directly related to poor sealant application or performance. Quite often, poor design, poor performance, or failures within the wall or roof components lead to building joint failures.

Poor quality windows that leak infiltrated water into a wall system may appear to be sealant problems. Building settlement or other one-time movement such as seismic racking often cause joints to move much more than anticipated.

Joint seal failures resulting from indirect root causes in most cases will not be corrected by replacing the joint sealant alone. Any problem solving process must identify the root cause and correct it to truly resolve the problem. If leaky windows are causing sealant adhesive bond loss in joints below them, the window leaks need to be stopped first. Any seal failures identified during the survey should be repaired. The result of the survey assessment is an understanding of the extent of the repair required.

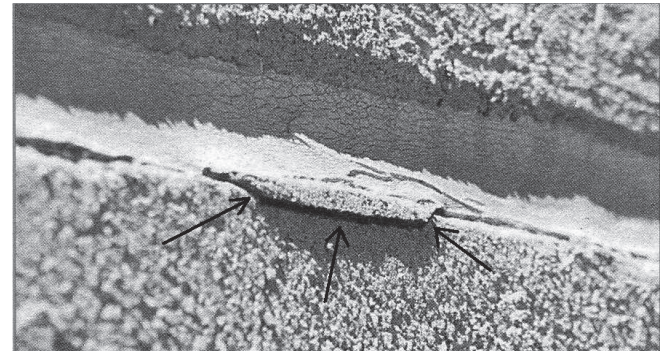

FIGURE 3.8 - SUBSTRATE FAILURE

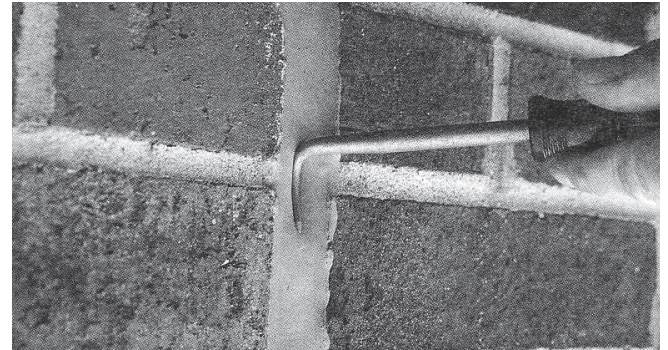

FIGURE 3.9 - SEALANT ADHESION PROBE TEST

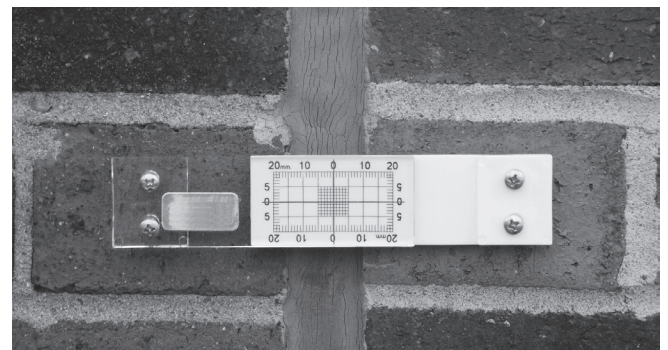

FIGURE 3.10 - SCRATCH GAUGE

## ASSESSING THE EXISTING CONDITIONS

With the survey completed, a general picture of the existing conditions can be visualized. If a partial survey was undertaken, the first assessment is to decide if further inspection is required. Are the majority of the observed problems occurring on one elevation or are they concentrated in one general area? It might be useful to perform an extensive inspection if the problems are not isolated.

## ASSESSING FAILURES

Making a sketch of the building elevations may be very helpful in assessing the existing conditions. The sketch should identify the joint seal failure locations along with the other areas of concern such as substrate cracking patterns.

The drawings and sketches should be reviewed to identify any patterns. Consider questions like: Are all joint failures of one type? Do they occur only in one repetitive area such as at the window corners? Has one time building movement caused a problem? Are there cracking patterns that show this? It is here that the assessor uses his building envelope knowledge and experience to truly understand the possible root cause of the problem(s).

## THE SURVEY SUMMARY

The results of the survey should be summarized to aid in choosing the appropriate joint seal restoration option. The summary should include the following information:

- The approximate linear feet, type, and age of the current joint sealant
- The type, location, number, and approximate linear feet of detected joint seal failures
- A description of the possible root cause(s) of the detected seal failures, including indirect causes

Doing a systematic, existing condition survey with a thorough assessment of the observations make choosing the restoration approach much easier.

## SECTION 4 – CHOOSING FROM THE JOINT SEALANT RESTORATION OPTIONS

At this point, you have enough information to choose from the joint seal restoration options. There are three options to choose from:

1) Do nothing. The inspection may have revealed that the problems being investigated were not related to the building joint seals. Often, interior water damage is caused by condensation or faulty mechanical equipment. In these cases, correcting the problem will not involve joint sealant restoration.

2) Spot repair. The spot repair approach addresses the areas of failure only. In this case, it is deemed that the most economical solution is to deal with the immediate problem only. This approach is often used when the majority of the joint seals are in good condition.

3) Total restoration. Total restoration involves renewing all building joint seals. In some cases, upgrading of glazing seals is done as well. The inspection may have revealed that along with varying modes of failure, the general condition of the sealant is towards the end of its service life and the best economic approach is to restore all building joint seals.

Joint sealants, like other building envelope components such as the roofing system or windows, do not have an infinite service life. In addition to the rigors of direct exposure to the elements, the joint sealant must withstand building movement as well. For this reason, building seals should be approached as a preventative maintenance item, just like the approach taken on a well-maintained roofing system. Annual inspections of the building envelope should be done to enable early detection and correction of localized problems, thereby maximizing the service life of all components.

At the point when it is determined that localized repair will not prevent the possibility of further failure, total building joint seal restoration should be undertaken. The total restoration approach might also make sense on buildings where the sealant is approaching the end of its service life and where repeated repairs to failures must be made. This is especially true on buildings where the cost of sealant application is high. Often the costs of mobilization (special staging, placing safety barriers, etc.) are a very significant part of the project cost. If in the foreseeable future total restoration will be required, it may make economic sense to undertake it now with the required failure repair. This avoids paying the cost of mobilization twice.

Section 4 describes the key considerations in choosing the project approach. It identifies the various restoration options typically available for a joint sealant restoration project. This section also includes a description of spot repair, total removal, replacement, and the bridge joint approach.

## 4 CHOOSING FROM THE JOINT SEALANT RESTORATION OPTIONS

Sealant life expectancy is the result of a number of variables. These variables include type of sealant, quality of sealant application, building design, movement, location, maintenance, and environmental exposures. There is no definitive answer on sealant life expectancy, as it will vary with the conditions that surround it. This is why the owners and design professionals must again use their knowledge and experience to judge whether total restoration is the best approach.

There are two possible approaches to total joint sealant restoration. The joint sealant can 1) be completely removed and replaced or 2) new sealant can be applied over the existing sealant. In most cases, leaving the original sealant in place results in a much larger width of sealant across the joint. This must be weighed against the cost savings resulting from not having to remove the old sealant. Often this approach is rejected due to aesthetic concerns. Jobsite mock-ups, which are discussed in SECTION 6, are helpful in visualizing the results of the two approaches. The approach of installing new sealant over the old sealant is acceptable provided it is done according to the sealant manufacturer's recommendations. Installing a very thin film of sealant over the old material is not a reliable application, as it will inhibit the sealant's ability to perform as it was designed. The service life of this application is shortened extensively because the new, thin film of sealant will not be able to properly accept thermal or structural expansion. For more information on sealant performance capabilities, see the Sealant Selector Guide Insert, or review the product data sheet(s).

Leaving the old sealant in place involves isolating the old sealant from the new sealant to prevent three-sided adhesion. This can be accomplished by the use of a bond breaker tape. In restoration of a fillet joint where additional material is placed over top of the old material, a bond breaker tape may also be required. The required backing material is dependent on joint design and movement requirements.

In applications where it is not feasible to completely remove the existing butt joint material(s) and the substrate cannot be restored to like-new conditions, a bridge joint can be applied. For bridge joint applications, Tremco offers Spectrem® Simple Seal. Spectrem® Simple Seal is installed over top of the old joint (Figure 4.1) with the new joint adhering to the face of the building (Figure 4.2). This detail is explained further in Appendix 8D.

After evaluating the sealant restoration options, you need to decide whether spot repair or total joint restoration is ideal for your application(s). Once you've determined which restoration option is best for your conditions, you can begin considering the sealant choices available for your restoration project.

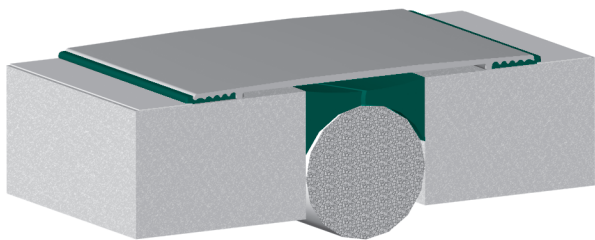

FIGURE 4.1 - BRIDGE JOINT - SPECTREM SIMPLE SEAL

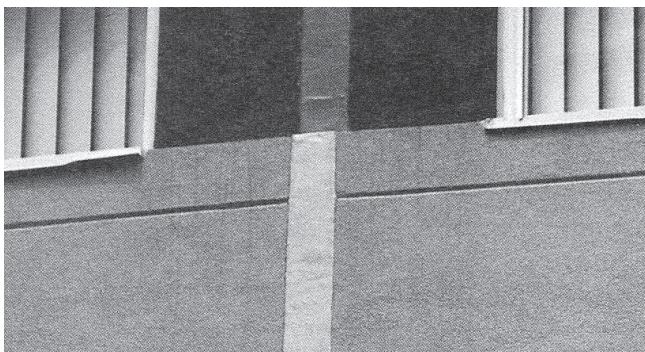

FIGURE 4.2 - BRIDGE JOINT

## SECTION 5 – SELECTING THE APPROPRIATE PRODUCTS

The inspection and analysis of the observations have determined the restoration approach as well as the project performance requirements. The key project performance requirements are:

- Substrate type and color
- Joint width(s) and configuration
- Joint movement
- The joint restoration approach (i.e. spot repair or total replacement)
- Sealant choice and performance properties

With these requirements established, an appropriate sealant can be selected. Tremco manufactures a complete line of high performance sealants and glazing tapes, as well as firestopping, residential, and specialty sealants. Your local Tremco Sales Representative is available to help you select the sealant(s) that are right for the project at hand.

### TREMCO SEALANTS

Selecting the correct sealant for the application may appear to be difficult. There are many products to choose from, along with the different sealant technologies such as urethanes, silicones, kraytons, butyls, acrylics, and pre-compressed, impregnated foams. Included in the back pocket of this guide are our Sealant Selection Guide and a chart titled Tremco Sealants – Certifications & Validations, which will assist you in selecting a sealant that meets your application needs. The sealants are listed for the application and, generally, there may be more than one sealant choice for any particular application. Further information can be obtained from the your local Tremco Sales or Technical Services Representative.

### SEALANT COLOR

Careful attention should be given to selecting an appropriate sealant color on any joint sealant restoration project. Often the building substrates and/or the existing joint sealant's color has changed from that originally installed due to normal weathering and various other factors. Selecting the original joint sealant color may not be the most appropriate choice. A custom color, matched to the existing color of the substrate or the existing joint sealant, may create more desirable aesthetics.

Tremco's multi-component sealants, Dymeric® 240FC, Vulkem® 445SSL, and THC 901, use a separate Color Pak along with a separate curative container making these sealants a three-component system. Tremco's Spectrem® 4-TS silicone sealant uses a separate Color Pak additive (like the one used with the above products), making it a two-component, field-tintable, moisture-curing silicone sealant option.

Section 5 explains the product selection process for various conditions. It describes key points in choosing the appropriate sealant

## 5 SELECTING THE APPROPRIATE PRODUCTS

## SEALANT STAINING AND DIRT PICK-UP

Sealant staining and dirt pick-up are potential issues that could affect the aesthetics of a restoration project. Plasticizer migration is generally considered the primary cause of staining, streaking, and dirt pick-up problems. While there are laboratory tests that can be conducted, they do not conclusively determine a sealant's propensity to stain any given façade material. Tremco recommends performing testing to investigate possible staining.

## SEALANT ADHESION AND COMPATIBILITY

The product data sheet gives typical guidelines on adhesion to most common substrates. Materials are considered compatible when objects that come into contact with each other exhibit neither adverse reactions nor loss of performance properties. The majority of common construction substrates are compatible with most Tremco sealants; however, we recommend that you check before proceeding, as primers or special preparation may be required. Unusual substrates can be reviewed with your local Tremco Sales or Technical Services Representative.

## JOINT MOVEMENT

As part of the investigation work described earlier, joint movement was either estimated or calculated. In addition, actual joint widths were measured. Make sure the selected sealant has an adequate movement capability and accommodates the actual joint widths. In extreme cases, it might be necessary to widen the joint so that the selected sealant can accommodate the expected range of movement. Widening the joint reduces the movement percentage to within the capability of the sealant design. Reference Appendix 8B, Calculating Joint Movement, for a complete description.

## SELECTING THE SEALANT(S) FOR YOUR PROJECT

Typically, there is more than one Tremco sealant that can meet the primary performance requirements of the particular project. The primary performance requirements include adhesion and compatibility with the substrates and/or existing sealants involved, accommodating actual joint movements, and delivering the required aesthetics over the expected service life of the sealant. The Tremco Sealants – Basic Uses and Classifications Chart (located inside the back pocket of this Guide) gives general descriptions, uses and performance characteristics. Any questions can be directed to your local Tremco Sales or Technical Services Representative.



## FINAL SEALANT SELECTION

The final sealant selection may be based on one predominant sealant characteristic. As a general guideline, silicone sealants should be used to repair or replace silicone sealants. Urethanes should be replaced with urethanes. Another alternative is illmod 600, a pre-compressed self-expanding, flexible, polyurethane joint sealant that is designed to seal against wind-driven rain, sound, draft and dirt. It can be used alone or in combination with another sealant chemistry to provide an exceptional performing dual-sealed joint. Contact your local Tremco Sales Representative whenever a switch to another sealant polymer family is desired, as there may be compatibility issues between different sealant polymers. A multi-component urethane is usually preferred on a project requiring a custom color. A project may require silicone for cap beading and a urethane for sealing porous substrate joints. Each portion of the project needs to be addressed individually. Tremco's extensive sealant product line ensures that the unique requirements of each restoration project can be met.

Complete product information, including data sheets, MSDS, and AutoCAD details are immediately available on our website at [www.tremcosealants.com](http://www.tremcosealants.com). Additional product inquiries and problems can be directed to your local Tremco Sales Representative or the Tremco Technical Services Group. The Tremco Technical Services Group can be reached at 866.209.2404.

## SECTION 6 – DETERMINING THE JOINT PREPARATION APPROACH

Selecting the right sealant for a joint sealant restoration project does not guarantee a successful outcome. Equally important is to ensure that the joints are properly prepared for sealant application. This includes existing sealant removal, substrate cleaning, and priming (if required). Establishing the most effective application procedure can be done by using a site mock-up (field trial) approach to evaluate the various options. This section describes the chronological steps taken to perform the site mock-up (field trial) procedure.

### EXISTING SEALANT REMOVAL

A technique and quality standard should be established for projects requiring sealant removal. The removal technique is usually dependent on the existing sealant type and the substrate type. In most cases the existing sealant should be removed completely. Most sealants, including relatively hard thermoplastic sealants such as putty, oil-based caulks or solvent-based acrylics, can be removed by using an abrasive grinding wheel (Figure 6.1). On porous substrates it is necessary to remove a fine layer of substrate to ensure a fresh, clean surface. If a grinding wheel cannot be used due to joint configuration, the sealant must be removed with another abrasive material. The sealant is first removed by cutting it out with a razor knife (Figure 6.2). The use of an abrasive pad (Scotch Brite) soaked with an appropriate solvent on non-porous substrates, such as aluminum, is usually required for complete removal. The abrasive pads are available in various grits, similar to sandpaper. The abrasive pad should remove the sealant without damaging the substrate. In cases where the existing sealant cannot be removed completely, compatibility between the existing and new sealant must be taken into consideration. Call Tremco Technical Services for details.

Elastomeric sealants are typically removed by first cutting as close as possible to the substrate without damaging it. Only a very thin film of sealant should remain. Depending on the joint configuration, removing the remaining sealant on a porous substrate can be accomplished by grinding. On non-porous substrates grinding is usually not feasible (as stated earlier, you can use the abrasive pad with solvent technique to remove the remaining sealant in these cases). An alternate to cutting out the sealant by hand with a razor knife is to use a power oscillating blade cutter (See Figure 6.3). This can improve efficiencies on larger jobs.

On occasion, it may not be necessary to completely remove the existing sealant. Partial removal is sometimes done when the replacement sealant is the same type as the existing sealant and the existing sealant is still well bonded. In these cases, a 1/16 to 1/8" (1.6 to 3.2 mm) thickness of old sealant is left at the bond line (Figure 6.4).

Section 6 gives details about the potential sealant removal, substrate preparation techniques, mock-up approach, and field evaluation.

## 6 DETERMINING THE JOINT PREPARATION APPROACH



FIGURE 6.1- USING A PORTABLE GRINDER



FIGURE 6.2 - USING A RAZOR KNIFE

## SUBSTRATE CLEANING

In each of these cases and in cases where the existing sealant will not be removed, the surface to which the replacement sealant will be applied must be clean, dry, and contaminant-free. The substrates should be structurally sound and free of defects. This can usually be accomplished by using one or more of the following techniques:

1) Wire Brush – Certain types of porous substrates such as concrete, stone, and brick have loose particles on the surface. Using a wire brush to prepare these types of surfaces will remove the loose particles.

2) Compressed Air – Blow out the joints with dry, oil free compressed air to remove dust and contaminants.

3) Solvent Wipe – Cleaning with an appropriate solvent using the “Two-Cloth” method will remove oil and dirt contaminants from the surface.

## THE “TWO-CLOTH” METHOD

Solvent cleaning requires the use of the “Two-Cloth” method (Figure 6.5). To effectively use this preparation method, follow these guidelines:

- Always use fresh, clean solvent and be sure to use the solvent type recommended for the particular surfaces to which it will be applied.
- Always consult and follow the instructions on the solvent material safety data sheet.
- Use clean, lint-free cloths. White cloths are preferred.
- Use one cloth soaked with solvent to clean the substrate and a second dry cloth to wipe the substrate dry immediately afterwards.
- Do not allow the solvent wiped surface to dry before wiping it with the second dry cloth.
- The cleaning action must be vigorous and with pressure.
- Clean only as much area as can be primed or sealed within four hours.
- If cleaned areas are exposed to rain, dust, or other contaminants, the surface must be re-cleaned.
- Continuously rotate the cloth to lift off and remove the surface contaminants loosened by the solvent.
- Always pour the solvent on the rag being used. Never dip the rag in the cleaning solvent as this contaminates the solvent.
- Change cloths frequently as they become soiled.



FIGURE 6.3 – POWER OSCILLATING BLADE CUTTER

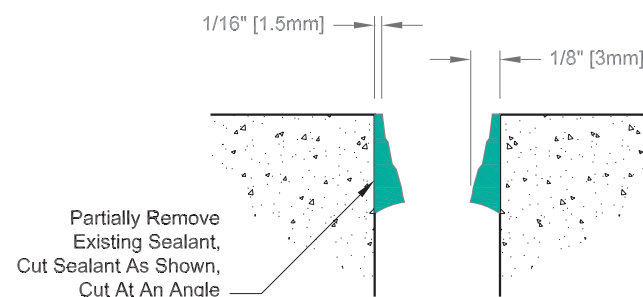

FIGURE 6.4 – PARTIAL SEALANT REMOVAL



FIGURE 6.5 – “TWO-CLOTH” METHOD

## PRIMING

Some sealants require a primer application to obtain strong and consistent adhesion to the substrate and/or to the old sealant. Priming does not replace or eliminate the requirement for substrate cleaning. Most sealants generally have good unprimed adhesion to most substrates but may require a primer to particular substrates. Check the sealant data sheet or contact Tremco Technical Service for specific instructions.

Apply primers using the following guidelines:

- Apply where sealant will contact the surface only. Mask if required to avoid staining non-sealant contact surfaces.
- Use only fresh primer. Dispense into a separate container for daily use. Changes in primer appearance may indicate contamination or an expired shelf life. If a change in primer appearance occurs, do not use.
- Keep primer containers sealed. Reseal immediately after use, as some primers are moisture sensitive and can be deactivated by extended exposure to moist air.
- Prime only as much area as you can prime and seal within the same day or as specified on the primer data sheet.
- Properly discard any left over primer in the daily use container at the end of each day.

## THE SITE MOCK-UP

It is Tremco's best recommendation that a site mock-up or field trial application be performed on any substantial building joint restoration project. This will allow for evaluation of the following options:

- Old sealant removal
- Substrate cleaning method
- Sealant selection
- Priming requirements
- Sealant bead configuration and appearance

Create a list of the potential options to be evaluated in the trial installation. Some of the options to be considered are listed below:

- Verify complete removal vs. partial removal vs. applying sealant over the top of existing material
- Various primers vs. no primer
- Various sealant types
- Diamond tipped vs. Carborundum grinding
- Test all the different substrate surfaces on the building such as, aluminum, brick, concrete, etc.
- Dry brush vs. solvent wipe

Trial installations should include each potential option that you are considering using. Select an area of the project where at least three to five linear feet of each option can be installed on each substrate type. The area should be easily accessible, since further checks of adhesion and visual appearance are required after cure. The trial installation should be used to determine the bead configuration and size. Good sealant bead configurations allow the sealant to perform as designed. Poor bead configuration can lead to premature failure of the joint sealant.

## EVALUATING THE SITE MOCK-UP

Once the trial application sealant(s) have fully cured (usually within 7 to 21 days) their adhesion should be checked and documented. The data should be recorded in a jobsite log, which ideally lists each sealant-substrate option. Perform a field adhesion test on each joint and note the results in the Jobsite Log sheet located inside the back pocket of this Guide.

## FIELD ADHESION TEST

The field adhesion test is simply a hand pull test of a cut area of joint sealant (Figure 6.6). It is a very useful tool for evaluating the effects of various cleaning methods and primers. It is also a good indicator of the fundamental adhesive properties of a sealant on a particular substrate. The field adhesion test procedures, according to ASTM C1193 Standard Guide for Use of Joint Sealants are as follows:

- 1) Cut through the sealant across the joint width
- 2) Cut 3" (76 mm) along the substrate/sealant interface on both sides
- 3) Grasp the sealant tab 1" (25 mm) from its bonded surface
- 4) Pull the tab of sealant at a 90° angle
- 5) Record the type of failure that occurs upon full extension to failure and the degree of force required (little or much)
- 6) Record the percent extension of the sealant tab at full extension prior to any failure

Use the field adhesion test results to eliminate any options that gave poor adhesion.



FIGURE 6.6 – FIELD ADHESION TEST

## TRIAL INSTALLATION RESULTS

Based on evaluating the trial installation, in addition to confirming the initial performance of the selected sealant(s), several project operating procedures and standards are established. All parties involved with the job should agree on:

- 1) The old sealant removal technique (if applicable) and acceptable results
- 2) Substrate cleaning technique and acceptable results
- 3) Primers (if any) to be used
- 4) Appearance including color of the sealant
- 5) Typical sealant bead configuration and dimensions

## TIMING OF THE TRIAL APPLICATION

Ideally the trial application should be completed prior to specifying and bidding the project. Doing this enables the Restoration Contractor to quote on a very specific basis. For complete sealant replacement projects, if the trial application cannot be completed first, make sure tenders have allowed for the potential costs of priming.

## SECTION 7 – PRODUCT INSTALLATION GUIDELINES

Installation of a joint sealant can be broken down into four (4) main steps:

- 1) Preparing the substrate, which includes
  - Removal of the old sealant
  - Cleaning the substrate
- 2) Installing the joint backing material
- 3) Priming the surface (if required)
- 4) Gunning the sealant
- 5) Tooling the sealant

Section 6 of this Guide outlines the requirements for Step 1 – Preparing the joint substrate. Steps 2–4 will be discussed below.

### JOINT BACKING MATERIALS

The backing material is required for proper joint configuration and to prevent three-sided adhesion. If three-sided adhesion occurs in a moving joint, the sealant is likely to fail due to the restricted movement ability created by the third bond. Backing material must also support the sealant as it is gunned into the joint under pressure and during the tooling process. Tooling forces the uncured sealant to flow throughout the joint substrate to ensure full wet-out and ultimately proper adhesion of the sealant.

The highest performing backing material is illmod 600® (Figure 7.1), a UV-stable, pre-compressed, self-expanding, flexible, polyurethane joint seal that provides protection against the elements. It is comprised of polyurethane foam that is impregnated with a flame-retardant, modified acrylic resin, making it flame-resistant, and treated with a pressure-sensitive adhesive on one side for easy installation. After positioning, the material self-expands to fill the joint and creates a permanently elastic, weathertight seal. It is used as an exterior or interior joint sealant in applications above or below grade when used as a secondary seal. Tremco sealants compatible with illmod 600 include Spectrem 1, Spectrem 2, Spectrem 3, and Spectrem 4-TS. Please contact Tremco Technical Services for questions regarding illmod 600 compatibility with other Tremco and non-Tremco sealants.

Another alternative joint backing product is backer rod (Figure 7.2). Backer rod is available in three generic types:

- Open cell
- Closed cell
- Soft (hybrid) type

Selecting a backing material that meets the need of your project and the selected sealant is essential to a successful sealant installation. Soft and closed cell are the preferred types of backer rod due to their resistance to moisture penetration; however, it is possible to use other bond breaking materials such as open cell backer rod or bond breaking tapes.

Section 7 summarizes the recommended sealant installation, including joint backing materials, and procedures for a typical joint sealant restoration project.

## 7 PRODUCT INSTALLATION GUIDELINES



FIGURE 7.1 – illmod 600



FIGURE 7.2 – INSERTING BACKER ROD

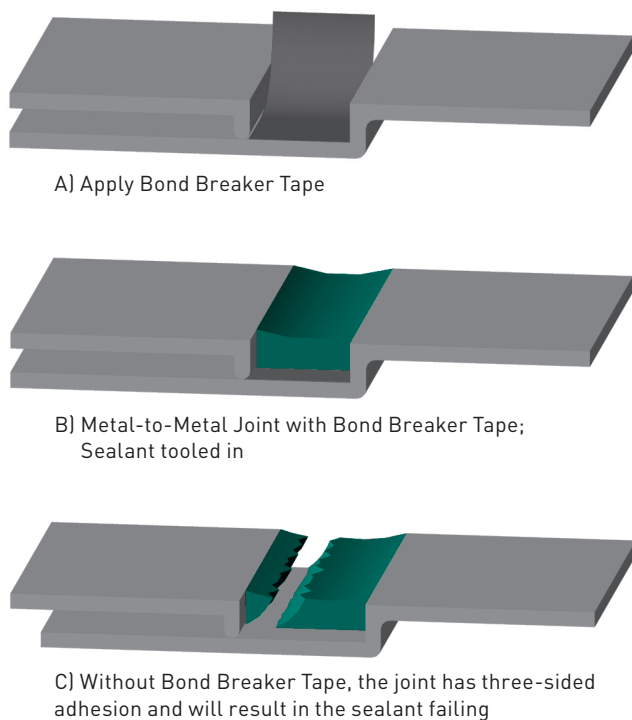

FIGURE 7.3 - APPLYING BOND BREAKER TAPE

Open cell backer rod is easily compressible and allows air to pass through it. Its sponge-like nature allows it to absorb and retain water within the pores of the material. However, constant water absorption of the backer rod is detrimental to the performance and longevity of both the sealant and substrate material, which is why it is not recommended for immersed conditions. Open cell backer rod can only be used in certain applications. Check with your local Tremco Sales Representative or contact Tremco Technical Services before using.

Closed cell backer rod is a foam material with closed pores or cells and has a tough plastic skin. It does not absorb water; however, it may release a gas if punctured during installation, often causing blisters in the sealant surface. It is also more difficult to compress, yielding a more snug fit. Closed cell backer rod is the preferred type of backer rod to use and can be used in most sealant applications.

The soft (hybrid) type backer rod is intended to combine the benefits of closed and open cell rod. It has an interior core of open cell foam surrounded by an outer core of closed cell foam with tough plastic skin. It is easily compressible and will not release a gas if punctured.

Generally, closed cell backer rod can be substituted for both open cell and the soft type. The soft type backer material can be generally substituted for open cell and closed cell backer rod. However, open cell cannot be substituted for closed cell or the soft type. Closed cell or soft type rod is the preferred type for exterior insulation finishing system (EIFS) joints and cavity wall joints. Closed cell backer rod should be used in all horizontal joints, below grade, and submerged applications. **Also, illmod 600 is an ideal backing material for any of these applications.**

When backer rod or illmod 600 cannot be installed due to the joint configuration, three-sided adhesion of the joint sealant must be prevented by other means. This is typically accomplished using a bond breaker tape (Figure 7.3). An adhesive backed polyethylene tape can be used for this purpose. The primary purpose of the tape is to prevent sealant adhesion to the topside of the tape.

#### ILLMOD 600 INSTALLATION

Tools needed for installation of illmod 600 are a tape measure, knife or scissors, spatula or putty knife, wood shims and water spray bottle.

Measure the width and depth of the joints that are to be sealed. Consult the illmod 600 Data Sheet or the Compressed Foam Tape Calculator on our website at [www.tremcosealants.com](http://www.tremcosealants.com) to determine the correct product size for your application. Cut off the first 2" (5 cm) of the roll and discard.



When cutting rolls to the appropriate length, leave an extra 1/2" (13 mm) for every 3' (1 m). Start filling the void from the bottom and work up, butting each new piece into the first. Use a putty knife or spatula to ease installation if needed (Figure 7.4). Apply a Tremco-approved sealant in between butt joints.

If the self-adhesive backing is too sticky, it can be temporarily neutralized by spraying the illmod 600 with water.

When using illmod 600 as backing material, recess the illmod 600 to the proper depth based on the specific joint design (Figure 7.5).

If the substrate is wet and the self-adhesive backing becomes ineffective, the use of shims is permitted to support the tape during expansion

Tips for Expansion Joint Installations: For horizontal expansion joints in walls, install the illmod 600 to the bottom of the joint and allow the material to expand. For intersections (Figure 7.6), always install illmod 600 in the horizontal joints prior to the vertical. Make sure to leave approximately 1/8" (3 mm) of extra seal as shown in Figure 7.6 to ensure a watertight seal at the intersection.

illmod 600 will self-expand to fill the joint within a short amount of time depending on the air temperature at time of installation. Although the material has formed a watertight seal at this point, it will continue to expand and fill evenly across the joint to a uniform hardness. This process requires additional time depending on temperatures. Allow the illmod 600 to fully expand to seal the joint before gunning the sealant. Contact Tremco Technical Services for additional information regarding illmod 600 expansion times.

If desired, illmod 600 can be topped with both backer rod and liquid-applied sealant (Figure 7.7).

## BACKER ROD INSTALLATION

Select an approved backer rod and size by following the directions on its data sheet to ensure proper compression of the rod. Install the rod direct from the reel or after pre-cutting to the required length. With a blunt instrument or roller, uniformly install rod at the required depth to obtain required sealant bead profile. It is recommended that backer rod be installed before priming, but it is acceptable to install the bond breaker after priming. The concern with installing the backing material after priming is the risk of primer contamination during the installation. Generally the depth of the sealant bead will equal half its width. Depth of backer rod is measured at the high point of the rod or center portion. See the sealant data page for specific requirements. Avoid puncturing, stretching, over-compression, and under-compression of the backer rod.

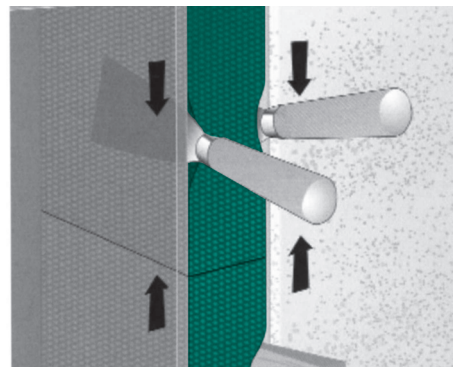

FIGURE 7.4 – illmod 600 INSTALLATION

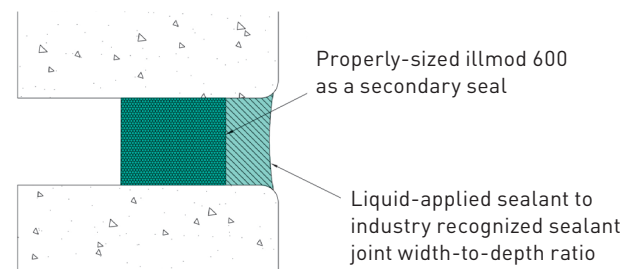

FIGURE 7.5 – illmod 600 INSTALLATION

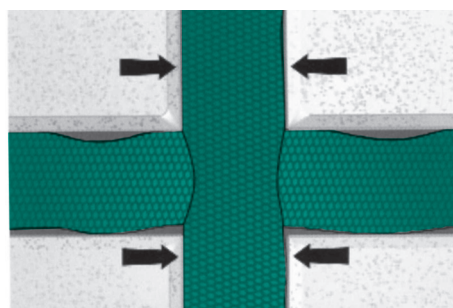

FIGURE 7.6 – illmod 600 INSTALLATION

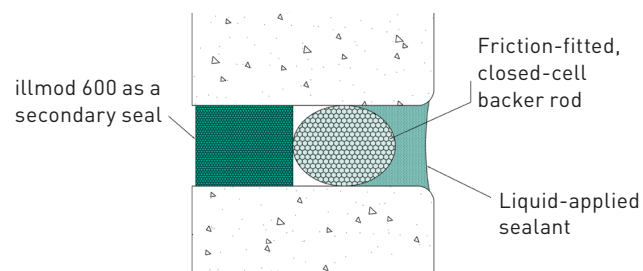

FIGURE 7.7 – illmod 600 INSTALLATION

## SEALANT INSTALLATION

Sealant installation should only be performed under acceptable environmental conditions. Industry standards for sealant installation call for a minimum substrate temperature of 40 °F (4 °C). However, illmod 600 can be installed at lower temperatures and in a variety of weather conditions. Contact Tremco Technical Services for assistance regarding installation of illmod 600 in severe weather. The maximum substrate application temperature Tremco recommends for urethanes is typically 100 °F (37 °C). The maximum substrate application temperature Tremco recommends for silicones is typically 120 °F (49 °C).

When temperatures drop below 40 °F (4 °C), condensation, frost, or ice can readily develop. Effective caulking work can still be conducted in temperatures below 40 °F (4 °C); however, there are certain precautions that should be considered. Temperatures less than 40 °F (4 °C) may make the sealant more difficult to gun and tool, as well as affect the sealant's ability to properly wet the substrate surface. If sealant restoration must be conducted in temperatures below 40 °F (4 °C), please reference Tremco's Cold Weather Application Guidelines, which can be found on Tremco's website at [www.tremcosealants.com](http://www.tremcosealants.com).

Illmod 600 can be installed in wet conditions; however, water can de-activate the pressure-sensitive adhesive backing. If needed, use shims to hold the product in place until it expands enough to support itself. (Note that illmod 600 must not be used as a primary seal where standing or ponding water will occur.) For application of traditional gunnable sealants in wet conditions, contact Tremco Technical Services or your local Tremco Sales Representative for guidelines related to your specific sealant choice. In addition to the threat of condensation and frost formation, cold weather conditions also increase the time required for the sealant to cure. Some sealants use a catalyst to speed up their cure and may be ideal for low temperature applications. Slower curing sealants may require protection during the longer cure period.

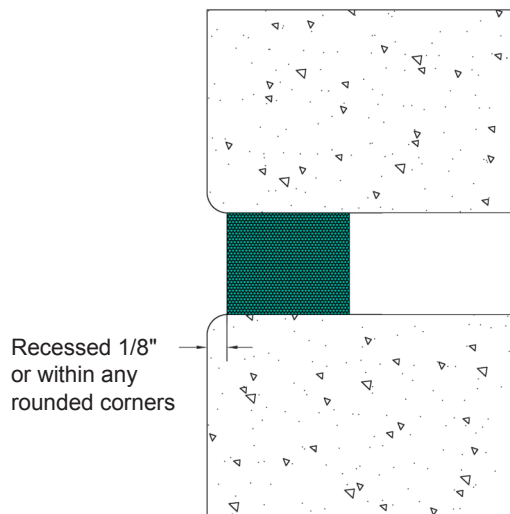

FIGURE 7.8 – illmod 600 INSTALLATION

Sealants should be gunned into the joint under pressure to ensure an intimate bond between the sealant and the substrate. The joint should be completely filled with all air displaced leaving no voids. The proper width, depth and configuration must be maintained on a continuous basis to eliminate localized problems.

Installation procedures for illmod 600 as the primary seal in a joint are the same as installation as a secondary seal, except that the material should be recessed 1/16 to 1/8" (2 to 3 mm) or within any rounded corners (Figure 7.8).

## TOOLING

Tooling refers to smoothing down and shaping the outer surface of the applied sealant using a metal spatula or a wood or plastic tooling stick. Tooling forces the sealant against the joint backing and substrate to ensure wet-out and no voids. It also allows the applicator to form the sealant surface into a slightly concave profile, which is preferable in a dynamic joint. Tooling smooths the surface for enhanced project aesthetics. It should be done immediately after sealant application to ensure a workable sealant bead. Dry tooling is always recommended (Figure 7.9), as wet tooling may contaminate the substrate surface, deterring proper sealant adhesion.

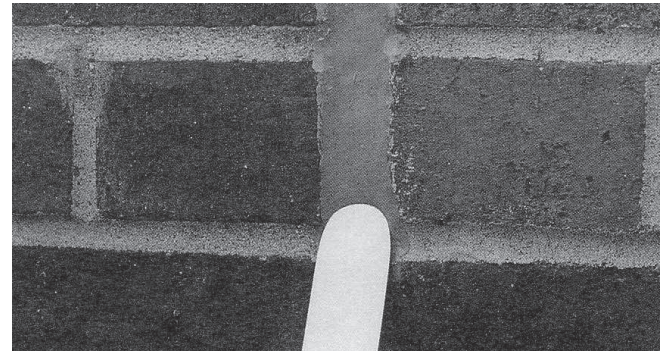

FIGURE 7.9 – DRY TOOLING

## MASKING

In order to prevent sealant smears, the application of masking tape along the sides of the joint is sometimes necessary. Masking tape is especially useful on surfaces where the clean up of excess sealant may be difficult. Apply the masking tape before primer application and remove it immediately after tooling the joint. This will create clean sealant lines, which yield an aesthetically pleasing appearance.

## CLEAN UP

Immediately remove all excess sealant and smears adjacent to the joint using an approved solvent cleaner. In most cases, xylene solvent will work well for sealant removal, although it may be possible to use other solvents such as MEK, Toluene, or similar mineral spirits. At times, it may also be possible to use soap & water. Avoid further contact with the sealant bead until it has completely cured. Access to these areas may need to be restricted until the product has fully cured (i.e. areas involving pedestrian/vehicular traffic, etc).

## SPECIAL PRODUCT INSTALLATION REQUIREMENTS

Consult and follow the instructions on product data sheets. Some products have special requirements that must be followed or product failures could occur.

8a. Types of substrates

8b. Calculating joint movement

8c. Sealant joint design

8d. Sealant joint profiles

# 8 APPENDIX

The use of building materials throughout the ages was typically based on available technology, aesthetics, proximity to the source and specific characteristics of the material. While this is still true today, the limitations posed by location are much reduced. This section will focus on the “recognition” aspects in identifying some of the materials that will be encountered during restoration, as well as generic precautions to be exercised once identification is complete. Specific procedures on these materials should be established with the assistance of a Tremco Sales or Technical Services Representative. This will maximize success in dealing with this broad range of sensitive substrates.

## MASONRY MATERIALS

### NATURAL STONE

Natural stone has experienced a resurgence of usage as an exterior building element since the late 1970’s. Technology assisted in the development of machinery, which was able to slice the stone in thinner pieces, producing more square footage per unit volume, hence reducing costs.

All natural stones will weather. Weathering is both the decomposition and the physical disintegration of stone. The thinner the stone is sliced, the greater the impact of weathering. Simply put, it is possible to diminish the interlocking process of coarse-grained stone by slicing the minerals too thin.

Natural stone is porous in nature and generally requires the use of a sealer before a sealant can be applied. Primers for sealants are usually required to promote a seamless bond due to the porosity at the bond line. Removal of old sealant from stone substrates usually requires grinding of the surface to get back to an uncontaminated, fresh material.

Certain types of stone, such as polished marble, are more susceptible to weathering than other natural stone products. Polished marble will not remain polished when exposed to the elements. Marble is technically defined as recrystallized limestone, for this reason it is vulnerable to mild solutions of acid from the atmosphere.

Granite is a very common material found on medium to large commercial projects. The exterior face of the granite is available in a polished or “flame” (rough face) finish. Sealant adhesion may vary from face to edge of panel and from polished to “flamed” areas in the same panel.

## **BRICK, BLOCK, & CONCRETE MATERIALS**

Brick and concrete blocks are man-made stone substitutes. They are designed as modular materials, lighter and easier to use than natural stone. The materials used in masonry construction may be highly porous and may absorb water moisture. This moisture must be controlled to prevent damage to the building, interior and exterior. Prolonged moisture in masonry may also have a detrimental effect on the bond line adhesion of the sealant. Primers may be required on highly porous masonry. Removal of old sealant from masonry substrates usually requires grinding of the surface to get back to an uncontaminated, fresh material.

Variables Which Affect Sealant Adhesion Characteristics:

- Density and type of concrete aggregate
- Surface treatment - masonry sealers
- Glazed and unglazed finishes
- Type of mortar
- Composition of brick, type of mixture
- Magnesium phosphate patches will not accept sealants
- Release agents used on concrete forms may contaminate the sides of the joint

## **LIGHTWEIGHT STONE VENEERS**

Modern technology allows us to slice stone very thin into a veneer laminated over a lightweight structural backing. The lightweight backing typically consists of a honeycomb pattern of a thin fibrous or metal weave material. We have seen very thin veneers, as thin as 3/16" (4.76 mm), which may pose problems in restoration. It may not be possible to use a grinder to remove old sealant material from a thin veneer or the veneer panel could be damaged. Also, the thickness of the veneer may prevent you from obtaining a proper bite to the side of the joint.

## **ARCHITECTURAL METALS**

### **COPPER**

When copper is new or properly cleaned, its color resembles that of a penny in mint condition. Age and environment quickly change the appearance through oxidation. Oxidation can change the surface color(s) to a coppery brown, brownish green, green, or light green. Usually all of these shades will be present, with variations seen by exposure to rain concentrations and the degree of exposure. Protected areas of the copper tend to stay in the coppery brown color range, where as copper exposed to heavy weathering in industrial locals generally exhibit a greenish color. Aesthetically all shades can be appealing depending on the application and desired patina. Substrate detection can be done by scraping away this oxidation in a discreet, non-critical spot, which should reveal the new-like, polished appearance. Typical uses are roofing, flashing, gutters and other drainage areas. Bright material is needed at the reseal area to ensure sealant adhesion. Aged or oxidized copper may inhibit sealant adhesion due to contaminants at the bond line.

## **BRONZE**

Bronze is an alloy of tin and copper (mostly copper). As it is more resistant to corrosion than pure copper, it tends to weather as more of a golden brown color, with a touch of green in the most severe exposures. It is harder and more durable than copper. It is used in ornamental work, banisters and railings, storefronts and entries. The bright metal is a muted copper tone, with a lighter and softer golden color. A fresh, clean bronze surface is required at the reseal area to ensure sealant adhesion.

## **LEAD-COATED COPPER & TERNE**

This material is recognized by a much more uniform oxidized appearance. Lead coated copper is almost always dull and generally has a slightly metallic, medium gray color. The uses are the same as with copper, but dispenses with the variable patina appearance. Check for the presence of solder joints, they may adversely affect adhesion. When lead is alloyed with tin, it can also be applied over steel sheeting, which is known as TERNE metal. Appearance-wise, the two are quite similar. Snipping a swatch through the base metal will reveal the steel "core" of the terne metal. This metal bonding configuration offers greater strength in typical gutter and drainage applications. Bright topcoat metal is required for resealing.

## **STEEL**

Being mostly iron, steel readily oxidizes. It is a poor sealant substrate, because of the continued oxidation that takes place, especially in corrosive urban and industrial environments. Tremco does not recommend sealing to uncoated steel because of the oxidation involved. The steel should be treated with a protective film, such as paint, to prevent oxidation. The oxidation process in steel is easily recognized by the "rust" we are all familiar with on the surface of the metal.

A limited exception to the continued oxidation problem that steel exhibits is Corten steel, which became popular in the 1970's. It will oxidize and rust as carbon steel, but at a much slower rate. It is difficult to distinguish from standard steel except in typical uses as exposed, ornamental or structural steel.

## **STAINLESS STEEL**

This material retains its reflective, silvery, metallic appearance due to the nickel and other alloying elements it's composed of. Because of its high strength, it can be used in an endless variety of applications. Its major uses are in flashing, closures and ornamental work. Stainless steel is available in a variety of finishes from a satin finish to a high polished/mirror finish.

## **GALVANIZED STEEL**

This material overcomes the problems of uncontrolled oxidation seen in common carbon steel, by the application of a thin zinc overcoat. The zinc separates the iron in the steel from the oxygen, preventing oxidation. It also prevents oxidation via the mechanism of galvanic action, in which ions of zinc are lost in corrosion prior to underlying or adjacent iron ions. In addition, the material is often painted for increased protection.

In its basic form, it is found as a light dull gray, with a fine, crystalline surface appearance. If the outer surface of zinc is compromised, then the steel below will rust. Due to its strength, it is used in many panel, roofing, and siding applications.

## **PORCELAINIZED METAL**

Many metals can be coated with porcelain, which is simply ground glass that fuses to form a continuous coating on the surface of the metal. It provides color and corrosion resistance to structural metals like steel and aluminum. It is very hard, brittle and long lasting unless cracked. The substrate can be detected by a surface not easily scratched with a knife.

## **ALUMINUM FINISHES**

Aluminum finishes include anodized, various paints, and mill finish.

Anodized finishes are created through anodizing, which is a method of chemically accelerating and controlling the oxidation process. The anodized coating is created from the metal, rather than being applied to it, which makes it integral. It will not chip, peel or blister. Standard colors are clear (silver gray), bronze (light, medium, dark) and black. A few special colors can be made by adding dyes during the anodizing process. The finish can be detected by a translucent sheen of the anodic coating.

A major drawback of the anodizing process is the inability of the process to make reproducible tint matches in a specific color range. Anodizing is a chemical process that may vary from batch to batch and piece to piece. Because of process variation, some sealants may have difficulties in obtaining adhesion to certain types or batches of anodized aluminum.

Painted finishes may include fluoropolymers, acrylic enamel, enamel, siliconized polyester, and urethane enamel. The critical performance elements of a painted finish are:

- The adhesion of the paint to the base substrate
- The ability to not chip or fade
- The ability of the paint to shed dirt/prevent staining

Some coatings that limit staining may also create adhesion problems for the sealant. Painted finishes can be detected by the slight imperfections on the surface made by dust particles during the spraying process.

Mill finish aluminum is a misnomer because it is aluminum material directly from the extrusion mill and has no type of surface finishing done to the material. The material must be thoroughly cleaned to remove dirt and grime from the surface. In place material will have evidence of oxidation as seen by a dull gray surface and pitted texture.

Another finish sometimes seen when working with aluminum is a conversion coating. A conversion coating is usually a finish that results when only some steps utilized in other finishing methods are used. The finish usually has a clear metallic appearance with a slight yellowish green cast.

## **ADDITIONAL CONSTRUCTION SUBSTRATES**

### **WOOD**

Wood can be categorized into two areas, treated and untreated lumber. Treated lumber will have some type of coating applied to the exterior surface. Exterior coatings usually consist of some type of surface water repellent coating. The sealant may or may not adhere to the coating, depending on the type. A primer may be required to attain adhesion.

Untreated wood has neither a coating nor a penetrating sealer applied to the surface. Certain types of woods may leach out resins or oils. These resins or oils may bleed to the surface and can affect adhesion of sealant to the wood surface. An important criteria in applying sealant to wood is to make sure that the wood is dry where the sealant bond line occurs. Tremco does not recommend sealing to any unfinished wood surface, including pressure treated lumber, in an exterior application.

### **GLASS**

Glass is commonly identified by a clear, hard smooth surface and is used in fenestration areas. This typical application is compounded with options such as tints, coatings, and applied frits. Coatings may be of a metallic type, for reflective glass or painted for spandrel glass. Sealant adhesion may vary dependent upon the coating.

Because the major ingredient in glass is silica, silicone sealants exhibit good adhesion to clear and tinted glass surfaces. Silicone sealants are used extensively in glazing applications such as cap, heel or toe beads. Currently available urethane sealants are not recommended for these applications because refracted ultraviolet rays may eventually break down the adhesive bond line of the urethane sealant if used in contact with the glass surface.

Some sealant types should not be used adjacent to an insulating glass unit. The by products emitted during the cure stage or the base chemistry of the sealant may damage the primary or secondary seals of the unit. Contact the Tremco Technical Services Group and the glass manufacturer for recommendations.



## PLASTIC

The main types of plastic, found mostly in glazing applications, are acrylic, polycarbonate, and reinforced fiberglass. They can be used in sheet form or in pre-molded shapes. A problem with using these materials as a glazing material is that their coefficient of thermal expansion is much greater than the adjacent aluminum framing materials. A designer must take into account the movement of the material due to thermal expansion and contraction.

If a sealant is in contact with the plastic glazing material then the joint design must allow for the movement without restricting the sealant or the plastic sheet. A bridge joint may be required in certain applications to provide for the movement.

Vinyl, PVC, and other plastics may be used as the structural framing material for residential and light commercial windows. Like all other glazing applications, thermal and structural movement relative to adjacent substrates should be considered.

## EXTERIOR INSULATION FINISHING SYSTEM (EIFS)

EIFS (Figure 8.1) is a composite system that combines the function of finish, structure, and insulation, which gives the appearance of stucco or light aggregate finish. This material can be identified by its lightweight structure. It produces a light, deadened sound when tapping on the surface.

Sealant concerns revolve around the finish and base coats in this built up system. Susceptibility of these coatings to damage will affect sealant removal efforts. Consideration for finding a balance between complete sealant removal and maintaining the integrity of the system makes remediation of this substrate complex. Substrate repairs may be required prior to recaulking. Contact the Tremco Technical Services Group for complete details.

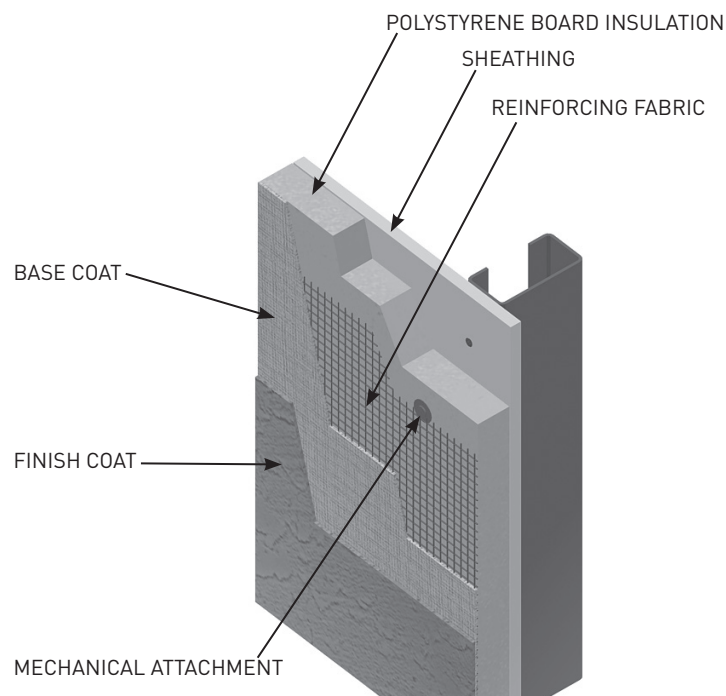

FIGURE 8.1 – TYPICAL EIFS WALL CONSTRUCTION

## APPENDIX 8B – CALCULATING JOINT MOVEMENT

In most Sealant Restoration Projects, joint movement is a result of substrate temperature change and its subsequent thermal expansion and contraction. Other potential sources of joint movement, such as creep and moisture-induced movements, are typically assumed to be zero. If live load deflections are deemed significant on a particular project they must be added to the calculated thermal movement.

In order to calculate joint movement, the substrate type, its anchoring pattern and design must be known. From this it can be determined how each element of the building will move in relation to each other. The amount of movement depends on the substrate type, its length that is free to move as well as the temperature it is exposed to.

Substrate	(in./in./°F)	(mm/mm/°C)
Aluminum	0.0000132	0.0000238
Brass	0.0000104	0.0000187
Bronze	0.00001-0.0000116	0.000018-0.0000209
Clay Masonry:		
Clay or shale brick	0.0000036	0.0000065
Fire clay brick	0.0000025	0.0000045
Clay or shale tile	0.0000033	0.0000059
Concrete Masonry:		
Dense aggregate	0.0000052	0.0000094
Lightweight aggregate	0.0000043	0.0000077
Concrete:		
Calcareous aggregate	0.000005	0.000009
Quartzite aggregate	0.000007	0.0000126
Copper	0.0000094	0.0000169
Glass	0.0000049	0.0000088
Iron:		
Cast, grey	0.0000059	0.0000106
Wrought	0.0000067	0.0000121
Lead	0.0000159	0.0000286
Magnesium	0.000016	0.0000288
Plaster, gypsum:		
Sand aggregate	0.0000065-0.00000675	0.0000117-0.0000122
Perlite aggregate	0.0000073-0.00000735	0.0000131-0.0000132
Vermiculite aggregate	0.0000084-0.0000086	0.0000151-0.0000155
Plastic:		
Acrylic sheet	0.000041	0.000074
Polycarbonate sheet	0.000038	0.0000684
Steel, carbon	0.0000067	0.0000121
Steel, stainless:		
300 alloys	0.0000094-0.0000096	0.000016-0.0000173
400 alloys	0.0000058-0.0000061	0.0000104-0.000011
Stone:		
Granite	0.0000028-0.0000061	0.000005-0.000011
Limestone	0.0000022-0.0000067	0.000004-0.000012
Marble	0.0000037-0.0000123	0.0000067-0.0000121
Sandstone	0.0000044-0.0000067	0.000008-0.000012
Slate	0.0000044-0.0000056	0.000008-0.00001
Travertine	0.0000033-0.0000056	0.000006-0.00001
Wood:		
Parallel to fiber	0.0000021-0.0000036	0.0000038-0.0000065
Perpendicular to fiber	0.000018-0.000032	0.0000324-0.0000576

TABLE 2 - COEFFICIENTS OF LINEAR EXPANSION

Linear Substrate Movement (LSM) can be calculated using this formula:  $LSM = \Delta T \times L \times CLE$

Where:

LSM is linear joint movement (in inches)

$\Delta T$  is the maximum substrate temperature range during the year (in °F)

L is the length of unrestrained substrate (in inches)

CLE is the substrate coefficient of linear expansion

EXAMPLE:

$$\Delta T = 180 \text{ °F (82 °C)}$$

$$L = 11'1" = 156"$$

$$CLE = 0.0000132 \text{ (aluminum)}$$

$$180 \times 156 \times 0.0000132 = 0.373" = 3/8"$$

$$\text{Linear Substrate Movement} = 0.373"$$

See Table 2 for a list of substrate coefficients of linear expansion and their average values. Wherever possible, the specific substrate coefficient of linear expansion should be established and used in the calculation.

### MAXIMUM SUBSTRATE TEMPERATURE DIFFERENCE

The maximum substrate temperature difference is a simple subtraction of the lowest temperature the substrate will exhibit from its highest temperature over the course of a year. The actual temperature extremes are dependent on geographic location, substrate type, color and exposure. As a rule of thumb, northern climates exhibit highs in the order of 150 °F (66 °C) (substrate temperature) and lows in the order of -30 °F (-34 °C). Southern climates see highs in the order of 170 °F (77 °C) (substrate temperature) or more and lows in the order of -10 °F (-23 °C).

### DIRECTIONAL JOINT MOVEMENT

Joint movement generally does not occur in one direction only. A portion of the movement may occur as expansion with the remaining portion as contraction. The actual thermal movement the sealant will experience depends on the substrate temperature and the joint width at the time of sealant installation. Building expansion joints will be widest during the winter months and narrowest during the summer months. Sealant applied in the summer must typically absorb more expansion than contraction.

On joint sealant restoration projects it is possible to calculate the linear directional joint movement (the joint movement in expansion and in compression). This should be done if excessive joint movement is anticipated. However, it is best to confer with an engineer to verify the actual movement due to load combinations and thermal considerations.

## APPENDIX 8C – SEALANT JOINT DESIGN

Sealant joint design is one of many key considerations in a carefully conceived building exterior. Effective treatment of sealant joints is a crucial factor in the ultimate success and longevity of the building envelope. Improperly designed joints will not perform correctly. The result may be a moisture infiltration problem, which defeats the original purpose of the building's exterior skin.

Sealant joints are theoretically designed to a nominal dimension. However, tolerances exist in both the manufacturing and the installation of the substrate materials. These tolerances will increase or decrease the width of the nominal joint dimension.

Joints that become smaller, due to construction tolerances, are of greater concern in joint design. When construction tolerances are not provided for, the resulting narrow joints are more prone to failure. When a narrow joint occurs, the anticipated joint movement remains the same. However, the narrow joint can no longer accommodate the same amount of movement that the larger joint can accommodate.

Construction tolerances may not be stated, yet joint design must account for them. For this reason the joint design ratio of a sealant is different than the movement capability of the sealant. If a sealant has maximum movement capability of  $\pm 50\%$  and the joint movement is  $1/4"$  (6 mm), a  $1/2"$  (13 mm) wide joint design theoretically would be correct; however, it does not take into account any construction tolerances. If the joint width necks down an  $1/8"$  (10 mm) to a joint width of  $3/8"$  (10 mm), the sealant can no longer accommodate the  $1/4"$  (6 mm) movement. For these reasons, joint design for a sealant that has  $\pm 50\%$  movement is a 4 to 1 ratio. If the movement across the joint, is  $1/4"$  (6 mm), the joint width is 4 times that amount, hence  $1/4" \times 4 = 1"$  (25 mm). The minimum industry standard for joint design ratio is 4 to 1. The 4 to 1 ratio usually takes into account construction tolerances and other miscellaneous items that affect performance. In applications where the movement capability of the sealant is less than  $\pm 50\%$ , the joint design ratio may be increased to a 6 to 1 ratio or an 8 to 1 ratio, depending on the sealant used.

The replacement sealant's joint design ratio can be obtained from the data sheet. Calculate the total joint movement for each typical joint on the project at hand. Multiply the expected joint movement by the joint design ratio to obtain the proper joint width.

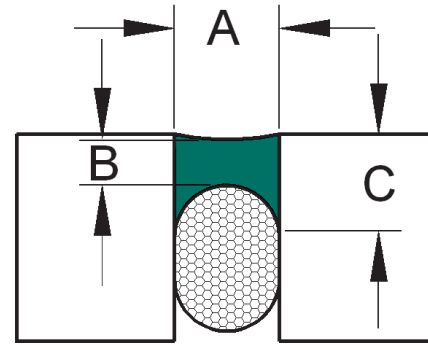

FIGURE 8.2 - BUTT JOINT

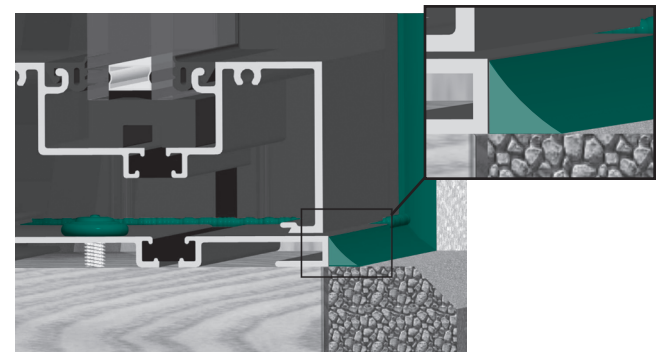

FIGURE 8.3 - FILLET JOINT

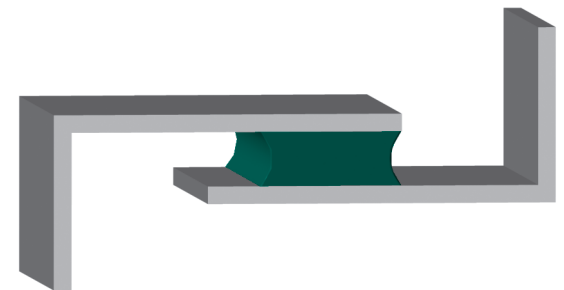

FIGURE 8.4 - LAP JOINT

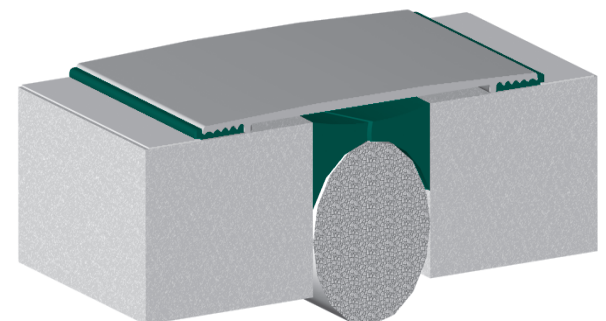

FIGURE 8.5 - BRIDGE JOINT

## APPENDIX 8D – SEALANT JOINT PROFILES

There are four basic shapes of sealant joints:

### **BUTT JOINT** (Figure 8.2)

The butt joint is the most common type of joint used. It consists of a gap or joint between similar or dissimilar materials. The gap may be either a control joint or an expansion joint. Expansion joints are generally designed to accommodate more movement than a control joint.

It is recommended that for joints 1/4 to 7/16" (6 to 11 mm), the sealant bead width (A) to depth (B) ratio be equal. For joints 1/2" (13 mm) wide to 1" (25 mm) for single components (or 2" (50 mm) for multi-component sealants), the sealant bead depth should remain at 1/2" (13 mm). For example, if the joint is 1" (25 mm) wide, the depth (at the top of the backer rod) should be 1/2" (13 mm). Likewise, if the joint is 1-1/2" (38 mm) wide for a multi-component material, the sealant depth (at the top of the backer rod) should be 1/2" (13 mm).

### **FILLET JOINT** (Figure 8.3)

This type of joint is best described as a joint in an inside 90° corner. The two substrates are approximately perpendicular to each other. There may or may not be a gap between the two substrates. If a gap exists between the substrates, a backer rod should be inserted with the top portion sticking out. If there is no gap and a backer rod cannot be inserted, then bond breaker tape should be applied into the corner. This will prevent three-sided adhesion of the sealant. Installed sealant should exhibit a minimum surface contact area of 1/4" (6 mm) onto each substrate.

### **LAP JOINT** (Figure 8.4)

A lap joint is either fixed, mechanically attached, or is a moving (slip) joint. The fixed lap joint application is typically retained by mechanical fasteners penetrating the two metal sheets. In this application with little or no gap between the two sheets, a non curing material such as Tremco Curtain Wall Sealant should be used. If a curable sealant is used, then the two metal sheet products should have a 1/4" (6 mm) or larger gap between the two to allow for backer rod and sealant.

### **BRIDGE JOINT** (Figure 8.5)

The term bridge joint is very definitive of the type of joint seal. This joint will span across two substrates with adhesion of the sealant to the outward face as opposed to the sides for a typical butt joint. In most applications, the bridge joint spans across an old sealant joint. In some applications, it is more practical to install a bridge joint in lieu of cut out and replacement of the old material. Bond breaker tape is placed at the center of the joint and defines the joint width for movement calculations.

Contact your local Tremco Sales Representative for any questions you may have concerning this section or any section in this guide.



## Sealant Usage Chart

Approximate number of cartridges per 25' (7.6 M) of joint							
Depth of Joint	Width of Joint						
	¼" (6.4 mm)	3/8" (9.5 mm)	½" (12.7 mm)	5/8" (15.9 mm)	¾" (19.1 mm)	7/8" (22.2 mm)	1" (25.4 mm)
¼" (6.4 mm)	1	2	2	3	3	4	4
3/8" (9.5 mm)	2	3	3	4	5	5	6
½" (12.7 mm)	2	3	4	5	6	7	8

Approximate number of sausages per 50' (15.2 M) of joint							
Depth of Joint	Width of Joint						
	¼" (6.4 mm)	3/8" (9.5 mm)	½" (12.7 mm)	5/8" (15.9 mm)	¾" (19.1 mm)	7/8" (22.2 mm)	1" (25.4 mm)
¼" (6.4 mm)	1	2	2	3	3	4	4
3/8" (9.5 mm)	2	3	3	4	5	6	7
½" (12.7 mm)	2	3	4	5	7	7	8

Linear feet (meters) per gallon							
Depth of Joint	Width of Joint						
	¼" (6.4 mm)	3/8" (9.5 mm)	½" (12.7 mm)	5/8" (15.9 mm)	¾" (19.1 mm)	7/8" (22.2 mm)	1" (25.4 mm)
¼" (6.4 mm)	320 (97.5)	213 (64.9)	160 (47.7)	128 (39.0)	107 (32.6)	91 (27.7)	80 (24.3)
3/8" (9.5 mm)	213 (64.9)	142 (43.2)	107 (32.6)	85 (25.9)	71 (21.6)	61 (18.5)	53 (16.1)
½" (12.7 mm)	160 (47.7)	107 (32.6)	80 (24.3)	64 (19.5)	53 (16.1)	46 (14.0)	40 (12.1)

Linear feet (meters) per cartridge							
Depth of Joint	Width of Joint						
	¼" (6.4 mm)	3/8" (9.5 mm)	½" (12.7 mm)	5/8" (15.9 mm)	¾" (19.1 mm)	7/8" (22.2 mm)	1" (25.4 mm)
¼" (6.4 mm)	27 (8.2)	18 (5.4)	13 (3.9)	11 (3.3)	9 (2.7)	8 (2.4)	7 (2.1)
3/8" (9.5 mm)	18 (5.4)	12 (3.6)	9 (2.7)	7 (2.1)	6 (1.8)	5 (1.5)	4 (1.2)
½" (12.7 mm)	13 (3.9)	9 (2.7)	7 (2.1)	5 (1.5)	4 (1.2)	4 (1.2)	3 (.9)

Linear feet (meters) per sausage							
Depth of Joint	Width of Joint						
	¼" (6.4 mm)	3/8" (9.5 mm)	½" (12.7 mm)	5/8" (15.9 mm)	¾" (19.1 mm)	7/8" (22.2 mm)	1" (25.4 mm)
¼" (6.4 mm)	50 (15.2)	33 (10.0)	25 (7.6)	20 (6.0)	17 (5.1)	14 (4.2)	13 (3.9)
3/8" (9.5 mm)	33 (10.0)	22 (6.7)	17 (5.1)	13 (3.9)	11 (3.3)	10 (3.0)	8 (2.4)
½" (12.7 mm)	25 (7.6)	17 (5.1)	13 (3.9)	10 (3.0)	9 (2.7)	7 (2.1)	6 (1.8)





3735 Green Road, Beachwood, OH 44122  
Phone: 216.292.5000 • 800.321.7906

220 Wicksteed Avenue, Toronto, ON M4H 1G7  
Phone: 416.421.3300 • 800.363.3213

[www.tremcosealants.com](http://www.tremcosealants.com)